

Part number:

021-10049

HYDROMA

HYDRAULICKÉ SYSTÉMY

**HIDROMA
SISTEMS**

UKŁADY HYDRAULICZNE

HYDROMA

ГИДРАВЛИЧЕСКИЕ СИСТЕМЫ

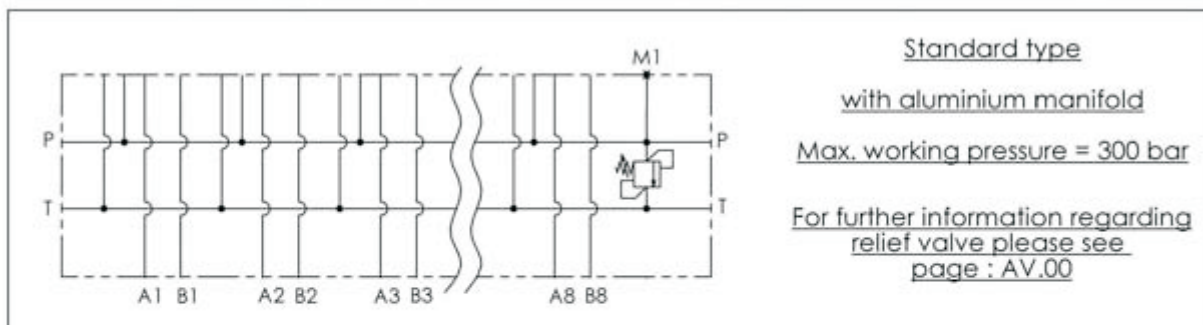
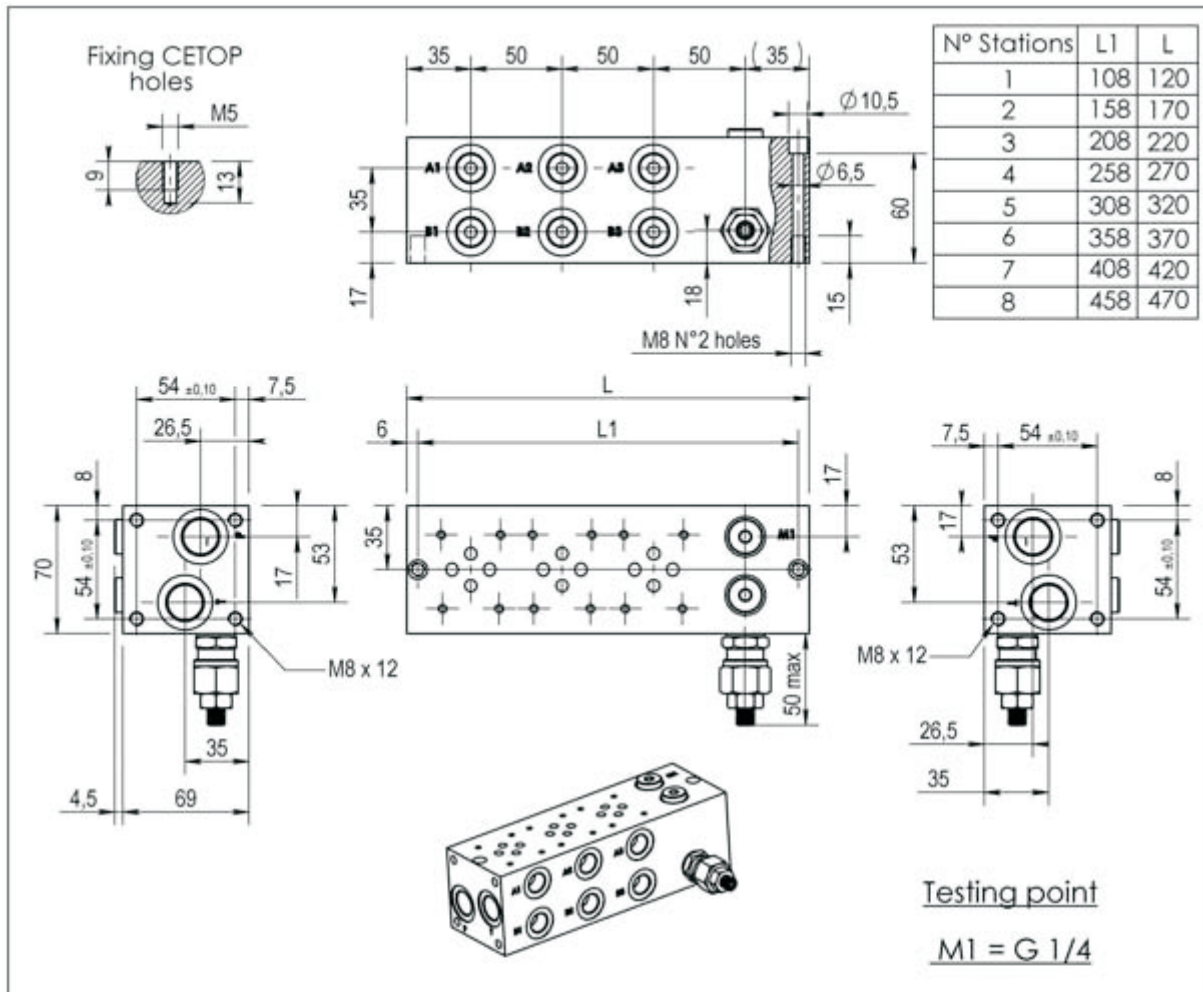

Ordering code

BMA 06 P 2 L 2 X - #

Aluminium monoblock

06 = CETOP 3 - NG 06

P = Parallel connection

2 = ports (P - T = G1/2 A - B = G 3/8)

Pressure range = 05 (5 - 50 bar)
20 (30 - 210 bar)
35 (100 - 350 bar)

Z = Maschined for relief valve
X = with built-in relief valve

1-2-3-4-5-6-7-8 = Stations number

L = On side ports